

# Dell™ Photo All-In-One Printer 924 User's Guide

Click the links to the left for information on the features and operation of your printer. For information on other documentation included with your printer, see [Finding Information](#).

To order ink or supplies from Dell:

1. Double-click the icon on your desktop.





2. Visit Dell's website: [www.dell.com/supplies](http://www.dell.com/supplies)
3. Order Dell printer supplies by phone. Refer to the *Owner's Manual* for the correct phone number for your country.

For the best service, make sure you have the Dell printer Service Tag available. See [Express Service Code and Service Tag number](#) for more information.

---

## Notes, Notices, and Cautions

-  **NOTE:** A NOTE indicates important information that helps you make better use of your printer.
-  **NOTICE:** A NOTICE indicates either potential damage to hardware or loss of data and tells you how to avoid the problem.
-  **CAUTION:** A CAUTION indicates a potential for property damage, personal injury, or death.

Information in this document is subject to change without notice.  
© 2005 Dell Inc. All rights reserved.

Reproduction in any manner whatsoever without the written permission of Dell Inc. is strictly forbidden.



Trademarks used in this text: *Dell* and the *DELL* logo, *Dell Picture Studio*, and *Dell Ink Management System* are trademarks of Dell Inc.; *Microsoft* and *Windows* are registered trademarks of Microsoft Corporation.

Other trademarks and trade names may be used in this document to refer to either the entities claiming the marks and names or their products. Dell Inc. disclaims any proprietary interest in trademarks and trade names other than its own.

Model 924

June 2005 SRV GC610 Rev. A00

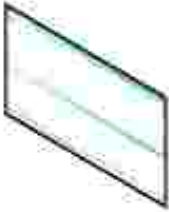
# Finding Information

What are you looking for?	Find it here
<ul style="list-style-type: none"><li>• Drivers for my printer</li><li>• My <i>User's Guide</i></li></ul>	<p><i>Drivers and Utilities CD</i></p>  <p>If you purchased your Dell computer and printer at the same time, documentation and drivers for your printer are already installed on your computer. You can use the CD to uninstall/reinstall drivers or access your documentation.</p> <p>Readme files may be included on your CD to provide last-minute updates about technical changes to your printer or advanced technical reference material for experienced users or technicians.</p>
How to set up my printer	<p><i>Setting Up Your Printer</i> poster</p> 
<ul style="list-style-type: none"><li>• Safety information</li><li>• How to set up and use my printer</li><li>• Warranty information</li></ul>	<p><i>Owner's Manual</i></p> 
Express Service Code and	Express Service Code and Service Tag number

Service Tag number



This label is located under the printer unit, behind the scanner support.

- Latest drivers for my printer
- Answers to technical service and support questions
- Documentation for my printer

#### Dell Support Website

The Dell Support website provides several online tools, including:

- Solutions - Troubleshooting hints and tips, articles from technicians, and online courses
- Upgrades - Upgrade information for components, such as memory
- Customer Care - Contact information, order status, warranty, and repair information
- Downloads - Drivers
- Reference - Printer documentation and product specifications

- How to use Windows XP
- Documentation for my printer

#### Windows XP Help and Support Center

1. Click Start → Help and Support.
2. Type a word or phrase that describes your problem, and then click the arrow icon.
3. Click the topic that describes your problem.
4. Follow the instructions shown on the screen.

# About Your Printer

- [Understanding the Printer Parts](#)
- [Setting Up Your Printer](#)
- [Using the Operator Panel](#)
- [Understanding the Automatic Paper Type Sensor](#)
- [Loading Paper](#)
- [Print Media Guidelines](#)

You can use the Dell Photo All-In-One Printer 924 to do a variety of things. A few important things to note:

- If your printer is connected to a computer, you can use either the printer operator panel or the printer software to create your projects.
  - You *do* need to connect your printer to a computer to scan, print, and fax.
  - You *do not* need to connect your printer to a computer to copy.
- 

## Understanding the Printer Parts

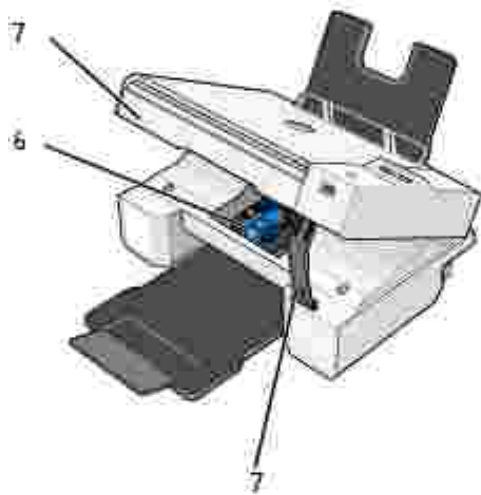
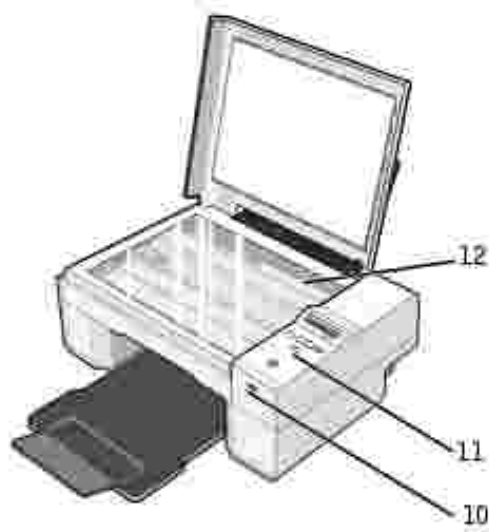
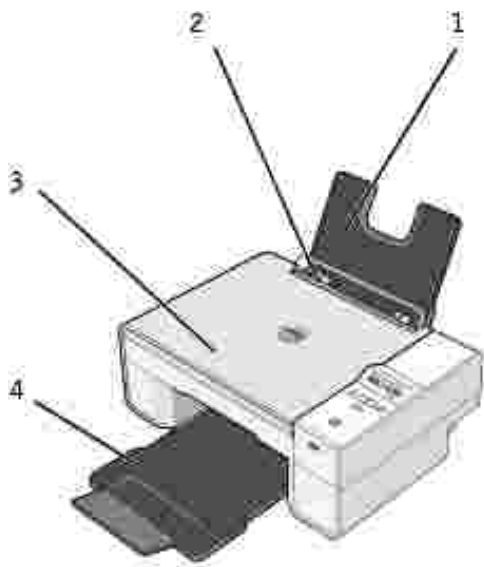

	Part:	Description:
1	Paper support	Part that supports loaded paper.
2	Paper guide	Guide that helps the paper feed into the printer properly.
3	Top cover	Top of printer that holds your document or photo flat while you scan it.
4	Paper exit tray	Tray that holds the paper as it exits the printer.  <b>NOTE:</b> To extend the paper exit tray, pull the tray straight out and flip out the extender.
5	Printer unit	Unit you lift to gain access to the ink cartridges.
6	Ink cartridge carrier	Carrier that holds two ink cartridges, one color and the other black or photo. For more information on your cartridges, see <a href="#">Replacing Ink Cartridges</a> .
7	Scanner support	Part under printer unit that keeps the printer open while you change ink cartridges.  <b>NOTE:</b> To close the printer for normal operation, lift the printer unit, press the scanner support to the right, and then lower the printer unit until it rests on the main body of the printer.

8	USB connector	Slot into which you plug the USB cable (sold separately). The other end of the USB cable plugs into your computer.
9	Power connector	Slot into which you plug the power cable.  <b>NOTE:</b> Insert the power cable into the printer before connecting the power cable into the wall outlet.
10	PictBridge USB connector	Slot into which you plug the USB cable (sold separately) that connects your printer to a PictBridge-enabled camera. For more information, see <a href="#">Printing Photos From a PictBridge-Compatible Camera</a> .
11	Operator panel	Panel on the printer you use to control copying, faxing, and printing. For more information, see <a href="#">Using the Operator Panel</a> .
12	Scanner glass	Surface on which you place your document or photo face down to copy, fax, or scan it.



## Setting Up Your Printer

 **NOTE:** The Dell AIO Printer 924 supports Microsoft® Windows® 2000, Windows XP, and Windows XP Professional x64 Edition.

Follow the instructions on your *Setting Up Your Printer* poster to install the hardware and software. If you encounter problems during setup, see [Setup Problems](#).







## Setting the Language on Your Printer

To set the language on your printer initially:

1. When you first power on your printer, press the Arrow buttons   to find your language.
2. Press the Menu button  to select your language.

## Resetting the Language on Your Printer





If you need to change the default language used on the operator panel, complete the following steps:

1. Press the Power button  to turn off the printer.
2. Press the Power button  and the up arrow button  simultaneously.
3. When the language settings appear, press the Arrow buttons   to scroll to your language.
4. Press the Menu button  to select your language.

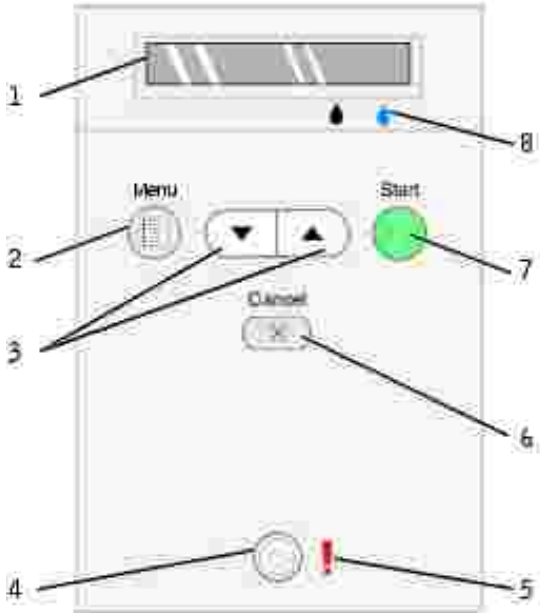
# Using the Operator Panel





The operator panel buttons allow you to scan, copy, and customize documents. The printer is on when the Power button  is illuminated.



	Use the	To
1	Display	<ul style="list-style-type: none"> <li>View the number of copies selected.</li> <li>View settings for Mode, Copy, Copies, Quality, Dark, Size, Zoom, and Maintenance. For more information, see <a href="#">Operator Panel Menus</a>.</li> </ul>
2	Menu button 	<ul style="list-style-type: none"> <li>Scroll through the available menus. Each time you press this button, the current option is saved and the next menu appears on the display.</li> <li>Feed newly loaded paper.</li> </ul>
3	Up/Down arrow buttons 	<ul style="list-style-type: none"> <li>Navigate menus and menu items.</li> <li>Decrease/increase number of copies.</li> <li>Change the selected mode.</li> </ul>
4	Power button 	Turn your printer on or off.
5	Error light	Alert you to errors such as paper out, paper jam, or low ink.
6	Cancel button 	<ul style="list-style-type: none"> <li>Cancel a scan, print, or copy job in progress.</li> <li>Cancel a copy job (using only the printer), and eject a page.</li> <li>Exit a menu, and return to the default settings.</li> </ul>
7	Start button 	Start the copying or scanning process. If the printer is in Scan mode, pressing this button opens the Dell All-In-One Center (if your printer is connected to a computer).

8	Ink Drop		<p>Determine the amount of ink remaining in each ink cartridge.</p> <ul style="list-style-type: none"> <li>• The black ink cartridge level is shown in the display above the black ink drop.</li> <li>• The color ink cartridge level is shown in the display above the blue ink drop.</li> </ul>
---	----------	--	---

## Operator Panel Menus

When you press the Menu button , the following menus appear. Press the Arrow buttons   to scroll through the options available in each menu. When the setting you want to use is displayed, press the Menu button  again to save the setting and move to the next menu available.

## Copy Mode

Menu:	Submenu item:	Settings:
Copy	Copy	<ul style="list-style-type: none"> <li>• Color*</li> <li>• Black</li> </ul>
	Copies (use arrow buttons to specify quantity)	
	Quality	<ul style="list-style-type: none"> <li>• Draft</li> <li>• Normal*</li> <li>• Photo</li> </ul>
	Dark (use arrow buttons to specify darkness setting)	
	Size	<ul style="list-style-type: none"> <li>• Letter*</li> <li>• Legal</li> <li>• B5</li> <li>• A4</li> <li>• A5</li> <li>• 3x6</li> <li>• 4x6</li> <li>• L</li> <li>• 2L</li> <li>• 5x7</li> <li>• Hagaki</li> <li>• 10x15 cm</li> <li>• 13x18 cm</li> </ul>
	Zoom	<ul style="list-style-type: none"> <li>• 25%</li> <li>• 50%</li> <li>• 75%</li> <li>• 100%*</li> <li>• 125%</li> <li>• 150%</li> <li>• 175%</li> <li>• 200%</li> <li>• 4x6</li> <li>• 5x7</li> <li>• Letter</li> <li>• A4</li> <li>• L</li> </ul>



- 2L
- Hagaki

\* Factory default setting

## Scan Mode

The Scan submenu is only available if the printer is connected to a network adapter. If you choose Scan as the mode, you are prompted to choose the destination computer for the scanned document. You can scroll through the available computers by pressing the arrow buttons. Pressing the Menu button  selects the currently displayed computer name.

 **NOTE:** If your printer is connected locally, the Scan submenu does not appear; the host computer is automatically selected.

## Maintenance Mode

Menu	Submenu item
Maintenance	Align Cartridges
	Clean Cartridges
	Print Text Page
	Back

 **NOTE:** The Back option allows you to leave the Maintenance menu without making a selection. Choosing this option takes you back one menu level.

## Understanding the Automatic Paper Type Sensor

Your printer has an automatic paper type sensor that detects the following paper types:

- Plain
- Transparency
- Glossy/photo

If you load one of these paper types, the printer detects the paper type and automatically adjusts the Quality/Speed settings.

	Quality/Speed settings	
Paper type	Black and Color Cartridges Installed	Photo and Color Cartridges Installed
Plain	Normal	Photo
Transparency	Normal	Photo
Glossy/photo	Photo	Photo

 **NOTE:** Your printer cannot detect the paper size.

To choose paper size:

1. With your document open, click File→ Print.
2. In the Print dialog box, click Preferences or Properties (depending on your program or operating system).

The Printing Preferences dialog box opens.

3. On the Print Setup tab, select the paper size.
4. Click OK.

Unless you turn off the automatic paper type sensor, it always remains on. To turn off the automatic paper type sensor for a specific print job:

1. With your document open, click File→ Print.
2. In the Print dialog box, click Preferences or Properties (depending on your program or operating system).

The Printing Preferences dialog box opens.

3. Click the Print Setup tab.
4. Select the paper type from the Media Type drop-down menu.
5. Click OK.

To turn off the automatic paper type sensor for all print jobs:

1. In *Windows XP*, click Start→ Control Panel→ Printers and Other Hardware→ Printers and Faxes.

In *Windows 2000*, click Start→ Settings→ Printers.

2. Right-click the Dell Photo AIO Printer 924 icon.



3. Click Printing Preferences.
  4. Click the Print Setup tab.
  5. Select the paper type from the Media Type drop-down menu.
  6. Click OK.
- 

## Loading Paper

1. Fan the paper.



2. Center the paper on the paper support.
3. Adjust the paper guides so both are resting against the edges of the paper.

-  **NOTE:** Do not pull on both paper guides simultaneously. When one paper guide is moved, the other adjusts accordingly.
-  **NOTE:** Do not force paper into the printer. The paper should be flat against the paper support surface, and the edges of the paper should be flush against both paper guides.



---

## Print Media Guidelines

---

Load up to:	Make sure:
100 sheets of plain paper	<ul style="list-style-type: none"> <li>• The paper is centered between the left and right paper guides.</li> </ul> <p><b>NOTE:</b> Load letterhead paper with the top of the letterhead entering the printer first and facing up.</p> <ul style="list-style-type: none"> <li>• You select Draft, Normal, or Photo print quality.</li> </ul> <p><b>NOTE:</b> Do not select Draft if you have a Photo cartridge installed.</p>
20 sheets of banner paper	<ul style="list-style-type: none"> <li>• You remove any paper from the paper support before inserting banner paper.</li> <li>• You place a stack of banner paper on or behind the printer, with only the number of sheets required.</li> </ul> <p><b>NOTE:</b> You must select A4 Banner or Letter Banner paper size in Print Properties. Failure to do so will cause a paper jam. See <a href="#">Paper Problems</a>.</p> <ul style="list-style-type: none"> <li>• You load the leading edge of the banner paper into the printer against the right side of the paper support.</li> <li>• The banner paper is centered between the left and right paper guides.</li> <li>• You use banner paper designed for inkjet printers.</li> </ul>
10 envelopes	<ul style="list-style-type: none"> <li>• The print side of the envelopes faces up.</li> <li>• The envelopes are centered on the paper support, in between the left and right paper guides.</li> <li>• The stamp location is in the upper left corner and printed with landscape orientation.</li> </ul>  <p><b>NOTE:</b> For Japanese customers: If you are mailing within Japan, the envelope can be printed with portrait orientation with the stamp in the lower right corner or with landscape orientation with the stamp in the lower left corner. If you are mailing internationally, print landscape orientation with the stamp in the upper left corner.</p> <ul style="list-style-type: none"> <li>• The paper guide rests against the left edge of the envelopes.</li> <li>• You select the correct envelope size. Select the next biggest size if the exact envelope size is not listed, and set the left and right margins so that your envelope text will be correctly positioned.</li> </ul>
25 greeting cards, index cards, postcards, or photo cards	<ul style="list-style-type: none"> <li>• The print side of the cards faces up.</li> <li>• The cards are centered on the paper support, in between the left and right paper guides.</li> <li>• The paper guide rests against the left edge of the cards.</li> <li>• You select Normal or Photo print quality.</li> </ul>

25 sheets of photo or glossy paper	<ul style="list-style-type: none"><li>• The glossy side of the paper faces up.</li><li>• The paper is centered on the paper support, in between the left and right paper guides.</li><li>• You select Normal or Photo print quality.</li><li>• The paper is loaded vertically against the right side of the paper support.</li></ul>
10 iron-on transfers	<ul style="list-style-type: none"><li>• You follow the loading instructions on the packaging.</li><li>• The blank side of the transfer faces up.</li><li>• The transfer is centered on the paper support, in between the left and right paper guides.</li><li>• You select Normal or Photo print quality.</li></ul> <p><b>NOTE:</b> For best results, iron-on transfers should be fed one sheet at a time.</p>
50 transparencies	<ul style="list-style-type: none"><li>• The rough side of the transparencies faces up.</li><li>• The transparencies are centered on the paper support, in between the left and right paper guides.</li></ul> <p><b>NOTE:</b> You can load a single transparency into the paper support without removing plain paper.</p> <ul style="list-style-type: none"><li>• You select Normal or Photo print quality.</li></ul>

# Using the Printer

- [Printing](#)
  - [Copying](#)
  - [Scanning](#)
  - [Faxing](#)
- 

## Printing

### Printing a Document

1. Turn on your computer and printer, and make sure they are connected.
2. Load paper with the print side facing up. For more information, see [Loading Paper](#).



3. With your document open, click File→ Print.
4. To customize your print settings:
  - a. Click Preferences, Properties, Options, or Setup (depending on the program or operating system).

The Printing Preferences dialog box opens.

- b. On the Print Setup tab, select the print quality/speed, paper size, black and white or color printing, borderless printing, orientation, and number of copies.
  - c. On the Advanced tab, you can specify a 2-sided printing option, a specialized layout option, or if you want to use Automatic Image Sharpening.
  - d. After making the changes in Printing Preferences, click OK at the bottom of the screen to return to the Print dialog box.
5. Click OK or Print (depending on the program or operating system).

## Printing Photos

1. Load the photo paper with the print (glossy) side facing up. For more information, see [Print Media Guidelines](#).
2. Make sure you have a color cartridge and a photo cartridge installed. For more information, see [Replacing Ink Cartridges](#).
3. With your document open, click File→ Print.
4. To customize your print settings, click Preferences, Properties, Options, or Setup (depending on the program or operating system).

The Printing Preferences dialog box opens.



**NOTE:** If you are using the Dell Picture Studio,<sup>™</sup> select View All Printer Settings to view Print Properties.

5. On the Print Setup tab, select Photo, and then select the dpi settings for the photo from the drop-down menu.
6. Select the paper size, orientation, and the number of copies.



**NOTE:** Photo/glossy paper is recommended for printing photos.

7. When you are finished customizing your print settings, click OK.
8. Click OK or Print (depending on the program or operating system).
9. To prevent your photos from sticking together or smudging, remove each photo after it exits the paper exit tray.



**NOTE:** Before placing your prints in a nonadhesive photo album or frame, allow sufficient time for the prints to dry thoroughly (12 to 24 hours, depending on the ambient conditions). This maximizes the life of your prints.

## Print Borderless Photos



1. For best results, load photo/glossy paper, and make sure the print side is facing up. For more information, see [Print Media Guidelines](#).
2. Make sure you have a color cartridge and a photo cartridge installed. For more information, see [Replacing Ink Cartridges](#).
3. With your document open, click File→ Print.
4. To customize your print settings, click Preferences, Properties, Options, or Setup (depending on the program or operating system).

The Printing Preferences dialog box opens.

5. On the Print Setup tab, select Photo, and then select the dpi settings for the photo from the drop-down menu.
6. Select the Borderless check box, orientation of the photo, and the number of copies you want.
7. On the Advanced tab, select the borderless paper size from the drop-down menu, and click OK.
8. Click OK or Print (depending on the program or operating system).

## Printing Photos From a PictBridge-Compatible Camera

Your printer supports PictBridge-compatible cameras.

1. Insert one end of the USB cable into the camera.
2. Insert the other end of the USB cable into the PictBridge port on the front of the printer.





**NOTE:** When your printer is not connected to a computer, and a PictBridge-compatible camera is connected to your printer, most functions accessed from your printer's operator panel buttons are unavailable. These functions become available after you disconnect the PictBridge-compatible camera from your printer.

3. Turn on your digital camera. Refer to the instructions included with your camera for selection of the appropriate camera USB settings and PictBridge connection and usage information.

**NOTE:** For many digital cameras, there are two USB mode selections: computer and printer (or PTP). For PictBridge-compatible printing, the printer (or PTP) USB selection should be used. For more information, refer to the documentation included with your camera.

---

## Copying

To make copies, you can use the printer operator panel or your computer.



### Copying Documents Using the Operator Panel

1. Turn on your printer.
2. Load the paper. For more information, see [Loading Paper](#).
3. Open the top cover.
4. Place the document you want to copy face down on the scanner glass. Make sure the upper left corner of the front of the document aligns with the arrow on the printer.



5. Close the top cover.
6. Access the menu to change copy settings. For more information, see [Operator Panel Menus](#).
7. On the operator panel, press the Start button . The copy is made in the currently specified copy selection (Color or Black).

Copying appears on the display.

 **NOTE:** If you press the Start button  without specifying a copy selection, the copy is printed in color by default.

## Copying Documents Using Your Computer

1. Turn on your computer and printer, and make sure they are connected.
2. Load the paper. For more information, see [Loading Paper](#).
3. Open the top cover.
4. Place the document you want to copy face down on the scanner glass. Make sure the upper left corner of the front of the document aligns with the arrow on the printer.



5. Close the top cover.
6. Click Start→ Programs or All Programs→ Dell Printers→ Dell Photo AIO Printer 924→ Dell All-In-One Center.

The Dell All-In-One Center opens.

7. Select the number of copies (1–99) and color setting from the drop-down menu.
8. Click See More Copy Settings to:
  - o Choose a copy quality.
  - o Select the blank paper size.
  - o Select the original document size.
  - o Lighten or darken your document.
9. When you are finished customizing your settings, click Copy Now.

## Copying Photos Using Your Computer

1. Turn on your computer and printer, and make sure they are connected.
2. Load photo paper with the print side facing up. For more information, see [Print Media Guidelines](#).
3. Open the top cover.
4. Place the photo you want to copy face down on the scanner glass. Make sure the upper left corner of the front of the photo aligns with the arrow on the printer.



5. Close the top cover.
6. Click Start→ Programs or All Programs→ Dell Printers→ Dell Photo AIO Printer 924→ Dell All-In-One Center.

The Dell All-In-One Center opens.

7. Click Preview Now.
8. Adjust the dotted lines to fit around the portion of the image you want to print.
9. In the Copy section, select a quantity, and choose a photo option (Color Photo or Black and White Photo).
10. To customize your photo, click See More Copy Settings.
11. When you finish customizing your settings, click Copy Now.

## Copying Photos Without a Computer

1. Turn on your printer.
2. Load photo paper with the print side facing up. For more information, see [Loading Paper](#).
3. Open the top cover.
4. Place the photo you want to copy face down on the scanner glass. Make sure the upper left corner of the front of the photo aligns with the arrow on the printer.



5. Close the top cover.
6. From the Quality submenu, select Photo. For more information, see [Operator Panel Menus](#).
7. Press the Start button  .

## Changing Copy Settings

1. Click Start → Programs or All Programs → Dell Printers → Dell Photo AIO Printer 924 → Dell All-In-One Center.

The Dell All-In-One Center opens.

2. Select a copy quantity and color.
3. Click See More Copy Settings to:
  - Choose a copy quality.
  - Select the blank paper size.
  - Select the original document size.
  - Lighten or darken your document.
  - Reduce or enlarge your document.
4. Click the Advanced button to change options such as paper size and quality.
5. To make any changes, click the following tabs.

Click this tab:	To:
Print	<ul style="list-style-type: none"> <li>● Select the paper size and type.</li> <li>● Select borderless printing options.</li> <li>● Select the print quality.</li> </ul>
Scan	<ul style="list-style-type: none"> <li>● Select the color depth and scan resolution.</li> <li>● Auto-crop the scanned image.</li> </ul>
Image Enhancements	<ul style="list-style-type: none"> <li>● Sharpen your blurry images.</li> <li>● Adjust the brightness of your image.</li> <li>● Adjust the color correction curve (gamma) of your image.</li> </ul>
Image Patterns	<ul style="list-style-type: none"> <li>● Smooth the conversion of a gray image to a black and white dot pattern (dither).</li> <li>● Remove image patterns from magazines or newspapers (descreen).</li> <li>● Reduce the background noise on your color document.</li> </ul>

6. When you finish customizing your copy settings, click OK, and then click Copy Now.

## Scanning



You can scan with your printer using the printer operator panel or your computer.

1. Turn on your computer and printer, and make sure they are connected.
2. Open the top cover.
3. Place the document you want to scan face down on the scanner glass. Make sure the upper left corner of the front of the document aligns with the arrow on the printer.



4. Close the top cover.
5. Open the Dell All-In-One Center by clicking Start→ Programs or All Programs→ Dell Printers→ Dell Photo AIO Printer 924→ Dell All-In-One Center.

The Dell All-In-One Center opens.

 **NOTE:** You can also open the Dell All-In-One Center from the operator panel on your printer. When your printer is in Scan mode, press the Start button . The Dell All-In-One Center opens on your computer.

6. In the Send scanned image to: drop-down menu, select a program as your scan destination. For example, choose Fax to scan an image you want to fax.

 **NOTE:** If the program you want to use is not listed, select Search for more... in the drop-down menu. On the next screen, click Add to locate and add your program to the list.

7. Customize your scan settings.
8. Click Scan Now to complete your scan.



## Scanning Photos

1. Turn on your computer and printer, and make sure they are connected.
2. Open the top cover.
3. Place the photo you want to scan face down on the scanner glass. Make sure the upper left corner of the front of the photo aligns with the arrow on the printer.



4. Close the top cover.
5. Open the Dell All-In-One Center by clicking Start→ Programs or All Programs→ Dell Printers→ Dell Photo AIO Printer 924→ Dell All-In-One Center.

The Dell All-In-One Center opens.

 **NOTE:** You can also open the Dell All-In-One Center from the operator panel on your printer. When your printer is in Scan mode, press the Start button . The Dell All-In-One Center opens on your computer.

6. Click Preview Now to see your scanned image.
7. Adjust the dotted lines to fit around the portion of the image you want to scan.
8. In the Send scanned image to: drop-down menu, select the program you want to use.

 **NOTE:** If the program you want to use is not listed, select Search for more... in the drop-down menu. On the next screen, click Add to locate and add your program to the list.

9. Change any settings.
10. When you finish customizing your image, click Scan Now.

When your document has finished processing, the selected program opens.



## Scanning Multiple Pages or Images

1. Turn on your computer and printer, and make sure they are connected.
2. Open the top cover.
3. Place the first object you want to scan face down on the scanner glass. Make sure the upper left corner of the front of the sheet aligns with the arrow on the printer.



4. Close the top cover.
5. Open the Dell All-In-One Center by clicking Start→ Programs or All Programs→ Dell Printers→ Dell Photo AIO Printer 924→ Dell All-In-One Center.

The Dell All-In-One Center opens.

 **NOTE:** You can also open the Dell All-In-One Center from the operator panel on your printer. When your printer is in Scan mode, press the Start button . The Dell All-In-One Center opens on your computer.

6. In the Send scanned image to: drop-down menu, select a program as your scan destination.

 **NOTE:** If the program you want to use is not listed, select Search for more... in the drop-down menu. On the next screen, click Add to locate and add your program to the list.

7. In the Scan section, click See More Scan Settings.
8. Click the Advanced button.
9. Click Display Advanced Scan Settings to change advanced options.
10. On the Scan tab, click the Scan multiple items before output box.
11. Click OK.
12. When you finish customizing your settings, click Scan Now.

After you scan the first page, a prompt appears requesting the next page.

13. Place the next sheet on the scanner glass, and click Yes. Repeat until you finish scanning all pages.
14. When finished, click No. The program opens with the multiple pages scanned.



## Scanning a Photo or Document Across a Network



If your printer is attached to a network, you can scan photos or documents and have them sent to any computer on the network.

1. Open the top cover.
2. Place the document you want to scan face down on the scanner glass. Make sure the upper left corner of the front of the document aligns with the arrow on the printer.



3. Close the top cover.
4. Press the up arrow button  on the operator panel to change printer modes. When the LED displays Scan, press the Menu button  to save the selection.
5. From the submenu, scroll through the available computers until you find the one you want to send your photo or document to, and then press the Menu button  to save the selection.

The photo or document is scanned and sent to the specified computer.

 **NOTE:** If your printer is connected locally, the Scan submenu does not appear; the host computer is automatically selected.

## Editing Scanned Text Using Optical Character Recognition (OCR)

Optical Character Recognition (OCR) software converts a scanned image into editable text within a word-processing program.



 **NOTE:** Japanese and Chinese customers: Ensure you have OCR software installed on your computer. A copy of OCR software was provided with your printer and should have installed at the same time as your printer drivers.

1. Open the top cover.
2. Place the document you want to scan face down on the scanner glass. Make sure the upper left corner of the front of the document aligns with the arrow on the printer.



3. Close the top cover.
4. Open the Dell All-In-One Center by clicking Start→ Programs or All Programs→ Dell Printers→ Dell Photo AIO Printer 924→ Dell All-In-One Center.

The Dell All-In-One Center opens.

 **NOTE:** You can also open the Dell All-In-One Center from the operator panel on your printer. When your printer is in scan mode, press the Start button . The Dell All-In-One Center opens on your computer.

5. In the Send scanned images to: drop-down menu, select a word-processing or text-editing program.

 **NOTE:** If the program you want to use is not listed, select Search for more... in the drop-down menu. On the next screen, click Add to locate and add your program to the list.

6. In the How will the scan be used? drop-down menu, select To edit text (OCR and 300 DPI).
7. Click Scan Now.

The scanned text appears.

## Saving an Image on Your Computer

1. Click Start→ Programs or All Programs→ Dell Printers→ Dell Photo AIO Printer 924→ Dell All-In-One Center.

The Dell All-In-One Center opens.

2. In the Productivity Tools section, click Save an image on my computer.
3. Follow the instructions on your screen.

## E-mailing a Scanned Image or Document

To send scanned images or documents through e-mail:

1. Open the top cover.
2. Place the document or photo face down on the scanner glass. Make sure the upper left corner of the front of the item aligns with the arrow on the printer.



3. Close the top cover.
4. Click Start→ Programs or All Programs→ Dell Printers→ Dell Photo AIO Printer 924→ Dell All-In-One Center.

The Dell All-In-One Center opens.

5. Click Preview Now.
6. In the Productivity Tools section, click E-mail an image to a friend.
7. In the What is being scanned? menu, make a selection.
8. Follow the instructions on the screen to prepare the photograph for e-mail.
9. Click Next.
10. Open your e-mail program, write a note to accompany the attached photo, and then send it.

 **NOTE:** If you have questions about attaching documents to e-mail, consult the Help for your e-mail program.

## Enlarging or Reducing Images or Documents

If you are using your printer *with* a computer, you can enlarge or reduce your document between 25–400

percent using the Dell All-In-One Center.

If you are using your printer *without* a computer, you can enlarge or reduce your document by 25, 50, 100, 150, or 200 percent, and with Fit-to options using the operator panel.

1. Load the paper. For more information, see [Loading Paper](#).
2. Open the top cover.
3. Place the document or photo face down on the scanner glass. Make sure the upper left corner of the front of the item aligns with the arrow on the printer.



4. Close the top cover.
5. Click Start→ Programs or All Programs→ Dell Printers→ Dell Photo AIO Printer 924→ Dell All-In-One Center.

The Dell All-In-One Center opens.

6. Click Preview Now.
7. In the Productivity Tools section, select Enlarge or reduce an image.
8. Follow the instructions on the screen to select the size of your new image.
9. When you finish customizing your image, click Print Now.

---

## Faxing

To send a fax using this printer, you need to have the printer attached to a computer which is equipped with a modem and has Microsoft Fax installed. Before you do anything else, check to see that the Microsoft Fax software is on your computer:

Click Start→Programs or All Programs→Accessories→Communications.

For Windows XP:

- If you see Fax in the list that appears, you have Microsoft Fax on your computer. Continue with [Configuring Microsoft Fax Console \(Windows XP\) or Fax Service Management \(Windows 2000\)](#).
- If you do not see Fax in the list that appears, continue with [Installing Microsoft Fax Console in Windows XP](#).

For Windows 2000, Fax Service Management is automatically installed.

## Installing Microsoft Fax Console in Windows XP

1. Click Start→Settings→Control Panel. Under Pick a Category, click Add or Remove Programs.

The Add or Remove Programs dialog box opens.

2. Click Add/Remove Windows Components.
3. In the Components list, click to select the Fax Services box.
4. Click Next.
5. Click Finish.
6. In the Add or Remove Programs dialog box, click Close.

## Configuring Microsoft Fax Console (Windows XP) or Fax Service Management (Windows 2000)

To configure for fax:

1. Click Start→ Programs or All Programs→ Accessories→ Communications→ Fax→ Fax Console (Windows XP) or Fax Service Management (Windows 2000).
2. On the Welcome to Fax Configuration screen, click Next.
3. On the Sender Information screen, type the information you want to be displayed on your fax cover page, and then click Next.
4. On the Select Device for Sending or Receiving Faxes screen, click the modem that is installed in your computer in the Please select the fax device list.
5. If you want to disable the sending of faxes, click to clear the Enable Send check box.
6. Click the Manual answer button or Automatically answer after (user-defined number of rings) button.
7. Click to select the Enable Receive check box if you want to receive faxes.

 **NOTE:** Selecting the Enable Receive check box allows you to receive faxes but may cause the computer modem to answer all phone calls, in which case you may not receive voice mail.

8. Click Next.
9. On the Transmitting Subscriber Identification (TSID) screen, type the identification information (usually your fax number and your name or business name) in the TSID box. This information will appear in the header area of the faxes you send and identifies your fax machine to the person who receives your faxes.

 **NOTE:** The TSID is mandatory in some areas.

10. Click Next.

 **NOTE:** Steps 10–13 only occur if you enabled your machine to receive faxes in step 6.

11. On the Called Subscriber Identification (CSID) screen, type the CSID (appears to confirm that the fax is being sent to the correct recipient) that you want in the CSID box.
12. Click Next.
13. On the Routing Options screen, click to select the Print it on check box if you want each received fax to be automatically printed. When you select this check box, select the Dell Photo AIO Printer 924 to print the received fax.

 **NOTE:** Your printer must be on and connected to your computer in order to automatically print faxes.

14. Click to select the Store a copy in a folder check box if you want to create an archive copy of each fax. When you select this check box, you are able to specify the storage location for the fax copy.
15. Click Next.
16. Confirm the configuration settings in the Configuration Summary list, and then click Finish.

You are now ready to send or receive faxes.

## Faxing a Paper Document

To fax a single or multiple page paper document, use the Dell All-In-One Center.

1. Turn on your printer and computer, and make sure they are connected. Make sure your computer modem is connected to an active analog phone line. If you have DSL broadband service on the same phone line that you are using to fax, you must also have a DSL filter installed. Contact your Internet Service Provider for information.
2. Place your document on the scanner glass, and make sure the upper left corner aligns with the arrow on the printer.

3. Click Start→ Programs or All Programs→ Dell Printers→ Dell Photo AIO Printer 924→ Dell All-In-One Center.

The Dell All-In-One Center opens.

4. In the Dell All-In-One Center you can either:
  - o In the Scan or Fax section, send a single or multiple page fax. First, customize your fax job by answering the questions that appear on your screen.

To send a single-page fax, click Fax Now.

To send a multiple-page fax, click Advanced→ Scan multiple items before output→ OK.

- o In the Productivity Tools section, click Fax an image, and follow the instructions on the screen.

 **NOTE:** One of the questions on the screen asks if there is more than one page. If there are multiple pages in your fax, you should choose Yes, prompt me for each page.

## Faxing Electronic Documents

1. With the file open, click File→ Print.
2. In the printer list, select Fax.
3. Click Print, and then follow the instructions on the screen.

## Receiving a Fax Using Fax Console or Fax Service Management

1. Make sure that an active telephone line is connected to the wall jack connector on the computer modem.
2. Click Start→ Programs or All Programs→ Accessories→ Communications→ Fax.
3. Click Fax Console or Fax Service Management.

If you selected the Enable Receive check box when configuring Fax Console or Fax Service Management, you are now ready to receive a fax.

 **NOTE:** Selecting the Enable Receive check box allows you to receive faxes but may cause the computer modem to answer all phone calls, in which case you may not receive voice mail.

## Viewing Sent and Received Faxes Using Fax Console or Fax Service Management

 **NOTE:** Only faxes sent and received by Fax Console can be seen by Fax Console.

1. Click Start→ Programs or All Programs→ Accessories→ Communications→ Fax.
2. Click Fax Console or Fax Service Management.

View received faxes in the Inbox; view sent faxes in Sent Items.

## Viewing the Status of a Fax Using Fax Console or Fax Service Management

1. Click Start→ Programs or All Programs→ Accessories→ Communications→ Fax.
2. Click Fax Console or Fax Service Management.
3. The following folders appear:
  - o Incoming - faxes currently being received
  - o Inbox - faxes that have been received
  - o Outbox - faxes scheduled to be sent
  - o Sent Items - faxes successfully sent
4. Click the folder of your choice.
5. Click the fax in the right pane for which you want to view the status, and then click Preferences or Properties.
6. Click the General tab, and view the Status line.
7. Click Close when you are finished.

## Changing the Fax Configuration

1. Click Start→ Programs or All Programs→ Accessories→ Communications→ Fax, and then click Fax Console.
2. In Fax Console, click Configure Fax on the Tools menu to start the Fax Configuration Wizard.



# Understanding the Software

- [Using the Dell All-In-One Center](#)
- [Using Printing Preferences](#)
- [Using Dell Picture Studio](#)
- [Dell Ink Management System](#)
- [Removing and Reinstalling the Software](#)

The printer software includes:

- Dell All-In-One Center - Allows you to perform various scan, copy, fax, and print operations with newly scanned and previously saved documents and images.
- Printing Preferences - Allows you to adjust printer settings.
- Dell Picture Studio™ - Allows you to manage, edit, display, print, and convert photos and other types of images.
- Dell Ink Management System™ - Warns you when your printer is running low on ink.

---

## Using the Dell All-In-One Center



The Dell All-In-One Center allows you to:

- Scan, copy, fax, and use productivity tools.
- Select where you want to send the scanned image.

- Select the quantity and color of your copies.
- Access troubleshooting and maintenance information.
- Preview images you want to print or copy.
- Manage photos (copy them to folders, print them, perform creative copying).

To access the Dell All-In-One Center:

Click Start→ Programs or All Programs→ Dell Printers→ Dell Photo AIO Printer 924→ Dell All-In-One Center.

The Dell All-In-One Center includes four main sections: Scan or Fax, Copy, Productivity Tools, and Preview.

In this section:	You can:
Scan or Fax	<ul style="list-style-type: none"> <li>• Select the program where you want to send the scanned image.</li> <li>• Select the type of image being scanned.</li> <li>• Select how you will use the scan.</li> <li>• Select Fax Now.</li> </ul> <p><b>NOTE:</b> Click See More Scan Settings to view all settings.</p>
Copy	<ul style="list-style-type: none"> <li>• Select the quantity and color of your copies.</li> <li>• Select a quality setting for your copies.</li> <li>• Adjust the size of the scanned area.</li> <li>• Lighten or darken your copies (this can also be accomplished using the operator panel).</li> <li>• Enlarge or reduce your copies.</li> </ul> <p><b>NOTE:</b> Click See More Copy Settings to view all settings.</p>
Productivity Tools	<ul style="list-style-type: none"> <li>• Enlarge or reduce an image.</li> <li>• Repeat an image several times on one page.</li> <li>• Print an image as a multi-page poster.</li> <li>• Fax using your computer's modem.</li> <li>• E-mail an image.</li> <li>• Save an image on your computer.</li> <li>• Edit text found in a scanned document (Optical Character Recognition).</li> <li>• Modify an image with a photo editor.</li> </ul>
Preview	<ul style="list-style-type: none"> <li>• Select a portion of the preview image to scan.</li> <li>• View an image of what will be printed or copied.</li> </ul>

For more information about the Dell All-In-One Center, click Help in the Dell All-In-One Center.

## Using Printing Preferences

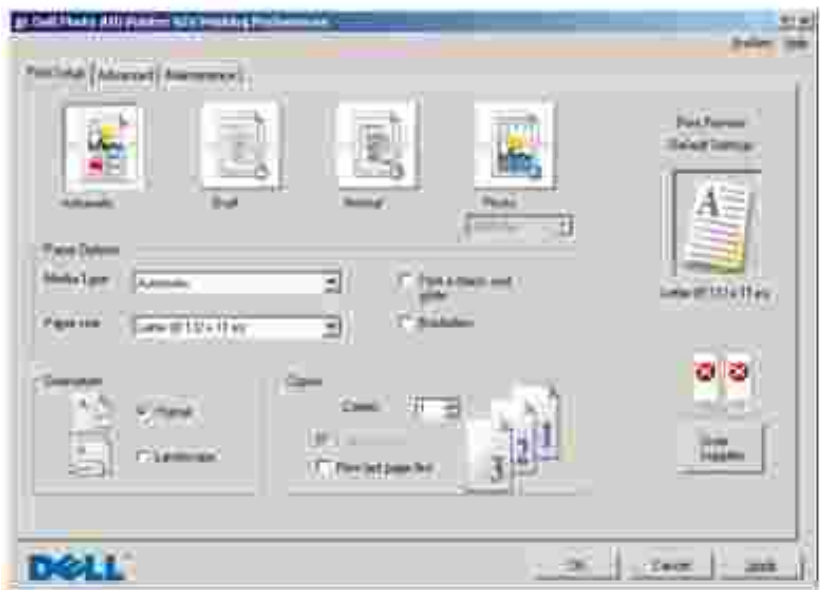

Printing Preferences allows you to change the various printer settings. You can change your printer settings in Printing Preferences depending on the type of project you want to create.

To access Printing Preferences:

1. With your document open, click File→ Print.

The Print dialog box opens.

2. In the Print dialog box, click Preferences, Properties, Options, or Setup (depending on the program or operating system).

The Printing Preferences dialog box opens.

To access Printing Preferences when a document is not open:

1. In Windows XP, click Start→ Control Panel→ Printers and Other Hardware→Printers and Faxes.

In Windows 2000, click Start→ Settings→ Printers.

2. Right-click the printer icon, and then select Printing Preferences.

 **NOTE:** Changes made to the printer settings from the Printers folder become the default settings for most programs.

## Printing Preferences Tabs

Printing Preferences includes three main tabs.

Tab	Options
Print Setup	Quality/Speed - Select Automatic, Draft, Normal, or Photo depending on your desired output quality. Draft is the fastest option but should not be selected if you have a photo cartridge installed.
	Media Type - Allows you to set the paper type manually, or have the printer sensor detect the paper type automatically.
	Paper Size - Select the size and type of paper.
	Print Color Images in Black and White - Print your color images in black and white to save the ink in your color ink cartridge.  <b>NOTE:</b> You cannot select this setting if you have selected Color Cartridge for all Black Printing.
	Orientation - Select how the document is arranged on the printed page. You can print using portrait or landscape orientation.
	Multiple Copies - Customize how the printer prints several photocopies of a single print job: Collated, Normal, or Print Last Page First.
Advanced	2-Sided Printing - Select this to print on both sides of the paper.
	Layout - Select Normal, Banner, Mirror, N-up, Poster, Booklet, or Borderless.
	Automatic Image Sharpening - Automatically select the best image sharpening level based on image content.
	More Options - Allows you to specify Appearance Mode and Complete-A-Print settings.
Maintenance	Install Print Cartridges
	Clean Print Cartridges
	Align Print Cartridges
	Print a Test Page
	Network Support
	Remove Japanese Postcard Residue

## Using Dell Picture Studio

In Dell Picture Studio, you can explore digital photography and learn how to organize, create, or print photos. There are three components to the Dell Picture Studio:

- Paint Shop Photo Album 5

Click Start→ Programs or All Programs→ Dell Picture Studio 3→ Paint Shop Photo Album 5→ Paint Shop Photo Album 5.

- Paint Shop Pro Studio

Click Start→ Programs or All Programs→ Dell Picture Studio 3→ Paint Shop Pro Studio→ Jasc Paint Shop Pro Studio.

- Dell.Shutterfly.com - Online Print Service

Click Start→ Programs or All Programs→ Dell Picture Studio 3→ Dell.Shutterfly.com - Online Print Service.

 **NOTE:** Depending on your operating system, some or all of these programs may not be available to you.

---

## Dell Ink Management System

Each time you print a job, a printing progress screen appears, which shows the progress of the print job as well as the amount of ink remaining and the approximate number of pages remaining in the cartridge. The page counter is hidden during the first 50 pages of cartridge use, until printing habits are learned and a more accurate count can be given. The number of pages remaining changes as a result of the type of print jobs the printer completes.

When your ink cartridge levels are low, a Low Ink Warning appears on your screen when you try to print. This warning is displayed every time you print until you install a new ink cartridge. For more information on replacing ink cartridges, see [Replacing Ink Cartridges](#).

When one or both of your ink cartridges are empty, the Reserve Tank window appears on your screen when you try to print. If you continue printing, the print job may not print as you expect.

If your black ink cartridge is out of ink, you can choose to print black from the color ink cartridge (Process Black) by selecting Complete-A-Print before clicking the Continue Printing button. If you select Complete-A-Print, and click Continue Printing, Process Black is used for all black printing until the black cartridge is replaced, or the option is cleared from More Options, located on the Advanced tab of the Printing Preferences. The Reserve Tank dialog does not display again until after the low ink cartridge has been replaced. The Complete-A-Print check box is automatically reset when a new or different cartridge is installed.



---

## Removing and Reinstalling the Software

If your printer does not function properly, or communication error messages appear when using your printer, you can remove and reinstall the printer software.

1. Click Start→ Programs or All Programs→ Dell Printers→ Dell Photo AIO Printer 924→ Uninstall Dell Photo AIO Printer 924.
2. Follow the instructions on the screen.
3. Restart your computer.
4. Insert the *Drivers and Utilities* CD, and then follow the instructions on the screen.

If the installation screen does not appear:

- a. In *Windows XP*, click Start→ My Computer.

In *Windows 2000*, double-click My Computer from your desktop.

- b. Double-click the CD-ROM drive icon. If necessary, double-click setup.exe.
- c. When the printer software installation screen appears, click Personal Installation or Network Installation.
- d. Follow the instructions on your screen to complete the installation.

# Ink Cartridge Maintenance

- [Replacing Ink Cartridges](#)
  - [Aligning Ink Cartridges](#)
  - [Cleaning the Ink Cartridge Nozzles](#)
- 

## Replacing Ink Cartridges

 **CAUTION:** Before performing any of the procedures listed in this section, read and follow the safety information in your *Owner's Manual*.

Dell ink cartridges are only available through Dell. You can order more ink online at [www.dell.com/supplies](http://www.dell.com/supplies) or by phone. To order by phone, see "Ordering Supplies" in your *Owner's Manual*.

Dell recommends Dell ink cartridges for your printer. Dell does not provide warranty coverage for problems caused by using accessories, parts, or components not supplied by Dell.

1. Turn on your printer.
2. Lift the printer unit, and position the scanner support between the tabs to hold it open.

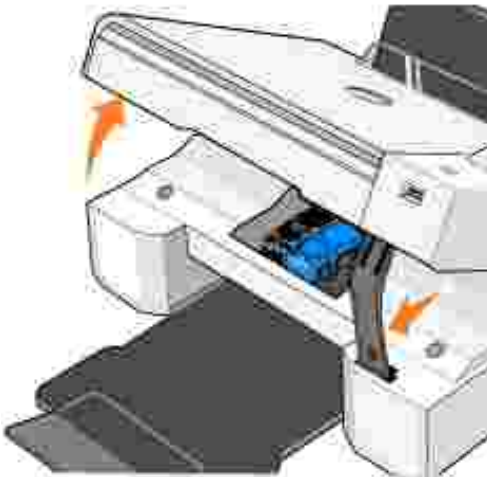

The ink cartridge carrier moves and stops at the loading position unless the printer is busy.

3. Press down on the ink cartridge lever to raise each ink cartridge lid.



4. Remove the old ink cartridges.



5. Store the cartridges in an air-tight container, such as the storage unit you received with your photo cartridge, or dispose of them properly.
6. If you are installing new ink cartridges, remove the sticker and transparent tape from the back and bottom of each ink cartridge.

 **NOTE:** The illustration below shows a black cartridge and a color cartridge (used for normal printing). For photo printing, use a photo cartridge and a color cartridge.



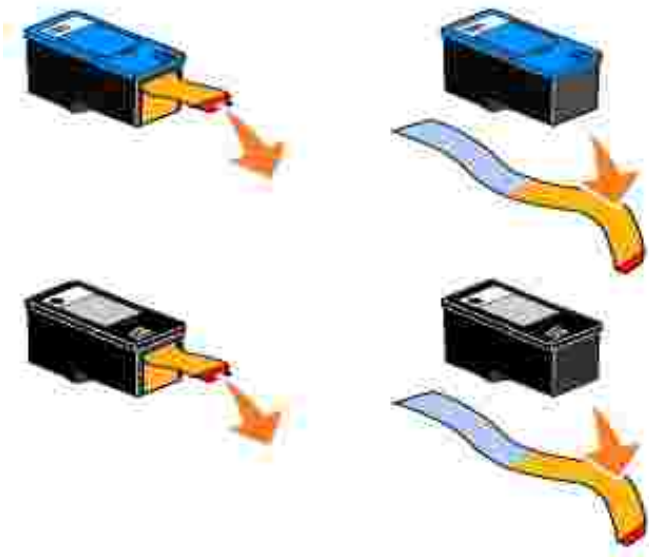

7. Insert the new ink cartridges. Make sure the black or photo ink cartridge is secure in the left ink cartridge carrier, and the color ink cartridge is secure in the right ink cartridge carrier.

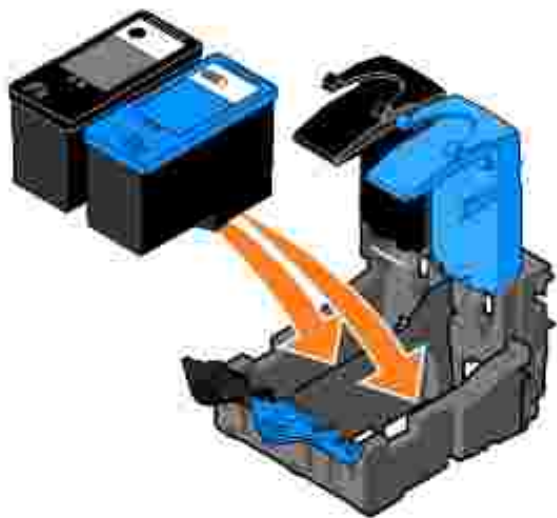

8. *Snap* each lid closed.

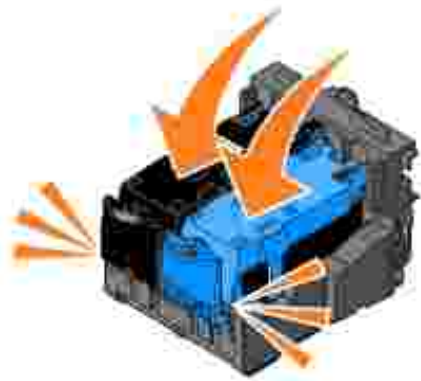

9. Lift the printer unit, and hold the scanner support up while lowering the printer unit until it is completely closed.

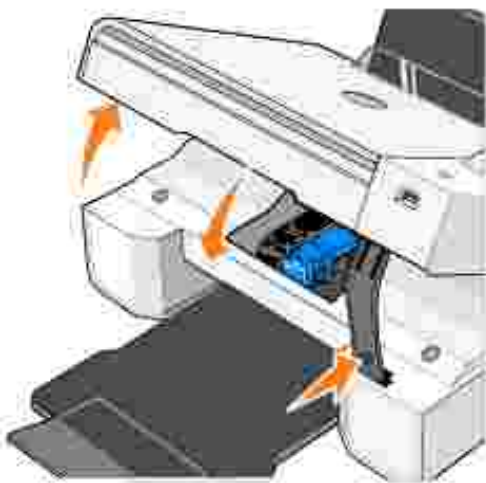

---

## Aligning Ink Cartridges

Your printer automatically prompts you to align the ink cartridges when they are installed or replaced. To verify your ink cartridges are aligned, you can print an alignment page. After you close the printer unit, press the Menu button . The alignment page begins printing. During printing, the operator panel display reads *Printing alignment page*. When complete, the message reads *Automatic Alignment Complete*. Your ink cartridges are now aligned for optimal print quality.

You may also need to align ink cartridges when characters are not properly formed or are not aligned at the left margin, or when vertical or straight lines appear wavy.

To align the ink cartridges:

1. Load plain paper. For more information, see [Loading Paper](#).
2. In *Windows XP*, click Start → Control Panel → Printers and Other Hardware → Printers and

Faxes.

In *Windows 2000*, click Start→ Settings→ Printers.

3. Right-click the Dell Photo AIO Printer 924 icon.
4. Click Printing Preferences.

The Printing Preferences dialog box opens.

5. Click the Maintenance tab.
6. Click Align Print Cartridges.
7. Click Print.

The ink cartridges align when the page prints.

---

## Cleaning the Ink Cartridge Nozzles

You may need to clean the nozzles when:

- White lines appear in graphics or solid black areas.
- Print appears smudged or too dark.
- Colors fade, do not print, or do not print completely.
- Vertical lines appear jagged, or edges appear rough.

To clean the ink cartridge nozzles:

1. Load plain paper. For more information, see [Loading Paper](#).
2. In *Windows XP*, click Start→ Control Panel→ Printers and Other Hardware→ Printers and Faxes.

In *Windows 2000*, click Start→ Settings→ Printers.

3. Right-click the Dell Photo AIO Printer 924 icon.
4. Click Printing Preferences.

The Printing Preferences dialog box opens.

5. Click the Maintenance tab.
6. Click Clean Print Cartridges.

7. If the print quality has not improved, click Print Again.
8. Print your document again to verify the improved print quality.
9. If you are still not satisfied with the print quality, wipe the ink cartridge nozzles, and then print your document again.

# Troubleshooting

- [Setup Problems](#)
- [General Problems](#)
- [Error Messages and Lights](#)
- [Improving Print Quality](#)

Follow these tips when you troubleshoot your printer:

- If the printer does not work, ensure that the printer is properly connected.
  - If an error message appears on the operator panel display, write down the exact message.
- 

## Setup Problems

### Computer Problems

Verify that your printer is compatible with your computer.

The Dell Photo AIO Printer 924 supports Windows 2000, Windows XP, and Windows XP Professional x64 Edition.

Make sure you turned on both your printer and your computer.

Check the USB cable.

- Ensure the USB cable is firmly connected to your printer and your computer.
- Shut down the computer, reconnect the USB cable as shown on the setup diagram for your printer, and then restart the computer.

If the software installation screen does not appear automatically, install the software manually.

1. Insert the *Drivers and Utilities* CD.
2. Click Install.

Determine if the printer software is installed.

Click Start→ Programs or All Programs→ Dell Printers→ Dell Photo AIO Printer 924. If Dell Photo AIO Printer 924 does not appear in the list of programs, the printer software is not installed. Install the printer software. For more information, see [Removing and Reinstalling the Software](#).

Set your printer as the default printer.

1. In *Windows XP*, click Start→ Control Panel→Printers and Other Hardware→ Printers and Faxes.

In *Windows 2000*, click Start→ Settings→ Printers.

2. Right-click Dell Photo AIO Printer 924, and select Set as Default.

Correct communication problems between the Dell All-in-One Center and the computer.

- Remove the USB cable from your printer and your computer. Reconnect the USB cable to your printer and your computer.
- Turn off the printer. Unplug the printer power cable from the electrical outlet. Reconnect the printer power cable to the electrical outlet, and turn on the printer.
- Restart your computer.

## Printer Problems

Ensure the printer power cable is firmly connected to the printer and the electrical outlet.

Determine if the printer has been held or paused.

1. In *Windows XP*, click Start→ Control Panel→Printers and Other Hardware→ Printers and Faxes.  
  
In *Windows 2000*, click Start→ Settings→ Printers.
2. Double-click Dell Photo AIO Printer 924, and then click Printer.
3. Make sure a check mark is not next to Pause Printing. If a check mark is next to Pause Printing, click Pause Printing to clear it.

Check for flashing lights on the printer.

For more information, see [Error Messages and Lights](#).

Ensure you installed the ink cartridges correctly and removed the sticker and tape from each cartridge.

Make sure you loaded the paper correctly.

For more information, see [Loading Paper](#).

Ensure a PictBridge-enabled camera is not connected to the printer.

For more information, see [Printing Photos From a PictBridge-Compatible Camera](#).

Ensure the printer displays the correct language.

For more information, see [Resetting the Language on Your Printer](#).

If you are using a wireless printer adapter, ensure you have the latest firmware updates.

For the latest updates and information, visit [www.support.dell.com](http://www.support.dell.com).

---

## General Problems

### Faxing Problems

Make sure you turned on both your printer and your computer, and the USB cable is properly connected.

Ensure the computer is connected to an active analog phone line.

Using the fax function requires a phone connection to the fax/modem in your computer.

When using an external modem, make sure it is turned on, and it is correctly connected to your computer.

## Paper Problems

Make sure you loaded the paper correctly.

For more information, see [Loading Paper](#).

Use only paper recommended for your printer.

For more information, see [Print Media Guidelines](#).

Use a smaller amount of paper when printing multiple pages.

For more information, see [Print Media Guidelines](#).

Make sure the paper is not wrinkled, torn, or damaged.

Make sure the paper is centered in the paper support, and the paper guides rest against the left and right sides of the paper.

Check for a paper jam.

*Using your printer and your computer*

Follow the instructions on the screen for clearing the paper jam.

*Using your printer only*

If the paper jam is located in the paper support:

1. Turn off your printer.
2. Firmly grasp the paper, and gently pull it from the printer.
3. Turn on your printer, and print the document again.



If the paper jam is not visible:

1. Turn off your printer.
2. Lift the printer unit, and position the scanner support between the tabs to keep it open.
3. Gently pull the paper from the printer.
4. Close the printer (scanner unit), turn on the printer, and print the document again.

---

## Error Messages and Lights

The following error messages can be found on your computer screen or operator panel display.

Error Code:	Error Message:	What it indicates:	Solution:
	Blinking Power Button	The printer has a paper jam or is out of paper.	If a paper jam exists, see <a href="#">"Paper Problems" on page 61</a> . If your printer is out of paper, see "Loading Paper" on page 20.
	Ink Low	The ink cartridge is running low on ink. The Low Ink Alert occurs when your ink cartridges reach levels of 25 percent, 15 percent, and 5 percent remaining.	Replace the ink cartridge. For more information, see "Replacing Ink Cartridges" on page 51.
	Reserve Tank	A print cartridge's available ink dot count is zero.	Order a new ink cartridge from Dell at <a href="http://www.dell.com/supplies">www.dell.com/supplies</a> , and replace the old ink cartridge.
1100	Paper jam	A paper jam exists in the printer.	Clear the paper jam. For more information, see <a href="#">Paper Problems</a> .
1101	Paper out	The printer is out of paper.	Load more paper into the printer. For more information, see <a href="#">Loading Paper</a> .
1102	Incorrect print head	The ink cartridge is not valid.	Replace the ink cartridge. For more information, see <a href="#">Replacing Ink Cartridges</a> .
1103	Missing print head	An ink cartridge has not been installed.	Install an ink cartridge in the empty carrier. For more information, see <a href="#">Replacing Ink Cartridges</a> .
1104	Print head order	The ink cartridges have been installed in the wrong carriers.	Swap the ink cartridges. For more information, see <a href="#">Replacing Ink Cartridges</a> .
1200	Print carrier stall	The ink cartridge carrier has stalled.	Disconnect the printer power cable, check for paper jams, and then reconnect the power cable.
1201	Print incomplete	Data error or incomplete data.	Press the Power button  to reset.
1203	Print head short	Short circuit detected in the print head.	Disconnect and then reconnect the printer power cable. Reinstall the ink cartridges. For more information, see <a href="#">Replacing Ink Cartridges</a> .
1204	Print head programming	Unable to program print head ID.	Reinstall the ink cartridges. For more information, see <a href="#">Replacing Ink Cartridges</a> .
1205	Mono TSR error	Problem in the mono TSR circuit.	Reinstall the black ink cartridge. For more information, see <a href="#">Replacing Ink Cartridges</a> .
1206	Color TSR error	Problem in the color TSR circuit.	Reinstall the color ink cartridge. For more information, see <a href="#">Replacing Ink Cartridges</a> .
1208	Incorrect home position	The printer is unable to locate the cartridge home position.	Clear the carrier jam and press the Start button  .
2100	Unlock scanner	The scan carrier has stalled.	Turn off the printer, wait a few seconds, and then turn on the printer.



# Improving Print Quality

If you are not satisfied with the print quality of your documents, there are several different ways to improve the print quality.

- Use the appropriate paper. For example, use Dell Premium Photo Paper if you are printing photos with a photo ink cartridge.
- Use paper that is a heavier weight, bright white, or coated. Use Dell Premium Photo Paper if you are printing photos.
- Select a higher print quality.

To select a higher print quality:

1. With your document open, click File→ Print.

The Print dialog box opens.

2. Click Preferences, Properties, or Options (depending on your program or operating system).

The Printing Preferences dialog box opens.

3. On the Print Setup tab select a higher quality setting.
4. Print your document again.
5. If the print quality does not improve, try aligning or cleaning the ink cartridges. For more information on aligning, see [Aligning Ink Cartridges](#). For more information on cleaning ink cartridges, see [Cleaning the Ink Cartridge Nozzles](#).

For additional solutions, go to [support.dell.com](http://support.dell.com).

# Printer Specifications

- [Overview](#)
  - [Environmental Specifications](#)
  - [Power Consumption and Requirements](#)
  - [Fax Mode Capabilities](#)
  - [Print and Scan Mode Capabilities](#)
  - [Operating System Support](#)
  - [System Specifications and Requirements](#)
  - [Cables](#)
- 

## Overview

Memory	16MB SDRAM*
Connectivity	USB 2.0 (full speed)
Duty cycle (maximum)	3,000 pages/month
Printer life	18,000 pages
* The printer memory is not upgradeable.	

---

## Environmental Specifications

### Temperature/Relative Humidity

Condition	Temperature	Relative humidity (non-condensing)
Operation	15° to 32° C (60° to 90° F)	40 to 80%
Storage	1° to 60° C (34° to 140° F)	5 to 80%
Shipping	-40° to -60° C (-40° to -140° F)	5 to 100%

---

## Power Consumption and Requirements

Rated AC Input	100–240 VAC
Rated Frequency	50/60 Hz
Minimum AC input	100 VAC
Maximum AC input	240 VAC
Maximum input current	1.0 A
Average power consumption	
Standby mode	15 W
Operational mode	35 W

## Fax Mode Capabilities

When you scan to fax, your document will scan in at 100 dpi (dots per inch). You can fax both color and black and white documents.

In order for faxing to function properly:

- The printer must be connected to computer that is connected to an active phone line.
- The printer must be connected to a computer with a USB cable.

 **NOTE:** You cannot fax with a DSL (digital subscribe line), ISDN (integrated signature digital network), or cable modem.

## Print and Scan Mode Capabilities

Your Dell Photo AIO Printer 924 can scan from 50 to 19,200 dpi. Although your printer has this capability, Dell recommends using the preset resolutions.

### Black and White

Quality	Print resolution	Scan resolution
Quick	300 x 600 dpi	150 x 150 ppi
Normal	600 x 600 dpi	300 x 300 ppi
Photo	1200 x 1200 dpi	600 x 600 ppi

### Color

Quality	Print resolution	Scan resolution
Quick	300 x 600 dpi	150 x 150 ppi
Normal	600 x 600 dpi	200 x 200 ppi
Photo	1200 x 1200 dpi	300 x 300 ppi

## Operating System Support

The Dell Photo AIO Printer 924 supports:

Windows 2000

Windows XP

Windows XP Professional x64 Edition

## System Specifications and Requirements

Your operating system must meet the minimum system requirements.

Operating system	Processor	RAM (MB)	Hard disk (MB)
Windows 2000	Pentium 233	128	286
Windows XP	Pentium 300	128	500
Windows XP Professional x64 Edition	AMD Athlon 64, AMD Opteron, Intel Xeon with Intel EM64T support, or Intel Pentium 4 with Intel EM64T support	256	500

## Cables

Your Dell Photo AIO Printer 924 uses a Universal Serial Bus (USB) cable (sold separately).



# Regulatory Notices

- [FCC Notices \(U.S. Only\)](#)
- [IC Notice \(Canada Only\)](#)
- [CE Notice \(European Union\)](#)
- [EN 55022 Compliance \(Czech Republic Only\)](#)
- [VCCI Notice \(Japan Only\)](#)
- [MIC Notice \(Republic of Korea Only\)](#)
- [Polish Center for Testing and Certification Notice](#)
- [BSMI Notice \(Taiwan Only\)](#)
- [NOM Information \(Mexico Only\)](#)
- [ENERGY STAR® Compliance](#)

Electromagnetic Interference (EMI) is any signal or emission, radiated in free space or conducted along power or signal leads, that endangers the functioning of a radio navigation or other safety service or seriously degrades, obstructs, or repeatedly interrupts a licensed radio communications service. Radio communications services include but are not limited to AM/FM commercial broadcast, television, cellular services, radar, air-traffic control, pager, and Personal Communication Services (PCS). These licensed services, along with unintentional radiators such as digital devices, contribute to the electromagnetic environment.

Electromagnetic Compatibility (EMC) is the ability of items of electronic equipment to function properly together in the electronic environment. While this device has been designed and determined to be compliant with regulatory agency limits for EMI, there is no guarantee that interference will not occur in a particular installation. If this equipment does cause interference with radio communications services, which can be determined by turning the equipment off and on, you are encouraged to try to correct the interference by one or more of the following measures:

- Reorient the receiving antenna.
- Relocate the device with respect to the receiver.
- Move the device away from the receiver.
- Plug the device into a different outlet so that the device and the receiver are on different branch circuits.

If necessary, consult a Dell Technical Support representative or an experienced radio/television technician for additional suggestions.

Dell™ devices are designed, tested, and classified for their intended electromagnetic environment. These electromagnetic environment classifications generally refer to the following harmonized definitions:

- Class A is typically for business or industrial environments.
- Class B is typically for residential environments.

Information Technology Equipment (ITE), including devices, expansion cards, printers, input/output (I/O) devices, monitors, and so on, that are integrated into or connected to the computer should match the electromagnetic environment classification of the computer.

**A Notice About Shielded Signal Cables:** Use only shielded cables for connecting devices to any Dell device to reduce the possibility of interference with radio communications services. Using shielded cables ensures that you maintain the appropriate EMC classification for the intended environment. For parallel printers, a cable is available from Dell. If you prefer, you can order a cable from Dell on the World Wide Web at [accessories.us.dell.com/sna/category.asp?category\\_id=4117](http://accessories.us.dell.com/sna/category.asp?category_id=4117).

Most Dell devices are classified for Class B environments. However, the inclusion of certain options can change the rating of some configurations to Class A. To determine the electromagnetic classification for your device, see the following sections specific for each regulatory agency. Each section provides country-specific EMC/EMI or product safety information.

---

## FCC Notices (U.S. Only)

Most Dell devices are classified by the Federal Communications Commission (FCC) as Class B digital devices. To determine which classification applies to your device, examine all FCC registration labels located on the bottom, side, or back panel of your device, on card-mounting brackets, and on the cards themselves. If any one of the labels carries a Class A rating, your entire device is considered to be a Class A digital device. If *all* labels carry an FCC Class B rating as distinguished by either an FCC ID number or the FCC logo, () , your device is considered to be a Class B digital device.

Once you have determined your device's FCC classification, read the appropriate FCC notice. Note that FCC regulations provide that changes or modifications not expressly approved by Dell could void your authority to operate this equipment.

This device complies with Part 15 of the FCC Rules. Operation is subject to the following two conditions:

- This device may not cause harmful interference.
- This device must accept any interference received, including interference that may cause undesired operation.

## Class A

This equipment has been tested and found to comply with the limits for a Class A digital device pursuant to Part 15 of the FCC Rules. These limits are designed to provide reasonable protection against harmful interference when the equipment is operated in a commercial environment. This equipment generates, uses, and can radiate radio frequency energy and, if not installed and used in accordance with the manufacturer's instruction manual, may cause harmful interference with radio communications. Operation of this equipment in a residential area is likely to cause harmful interference, in which case you will be required to correct the interference at your own expense.

## Class B

This equipment has been tested and found to comply with the limits for a Class B digital device pursuant to Part 15 of the FCC Rules. These limits are designed to provide reasonable protection against harmful interference in a residential installation. This equipment generates, uses, and can radiate radio frequency energy and, if not installed and used in accordance with the manufacturer's instruction manual, may cause interference with radio communications. However, there is no guarantee that interference will not occur in a particular installation. If this equipment does cause harmful interference to radio or television reception, which can be determined by turning the equipment off and on, you are encouraged to try to correct the interference by one or more of the following measures:

- Reorient or relocate the receiving antenna.
- Increase the separation between the equipment and the receiver.
- Connect the equipment into an outlet on a circuit different from that to which the receiver is connected.
- Consult the dealer or an experienced radio/television technician for help.

## FCC Identification Information

The following information is provided on the device or devices covered in this document in compliance with FCC regulations:

- Model number: 924
- Company name:

Dell Inc.  
One Dell Way  
Round Rock, Texas 78682 USA  
512-338-4400

## Fax Branding

The Telephone Consumer Protection Act of 1991 makes it unlawful for any person to use a computer or other electronic device, including fax machines, to send any message unless such message clearly contains in a margin at the top or bottom of each transmitted page or on the first page of the transmission, the date and time it is sent, identification of the business, other entity, or individual sending the message, and the telephone number of the sending machine or such business, other entity, or individual. The telephone number provided may not be a 900 number or any other number for which charges exceed local or long-distance transmission charges.

---

## IC Notice (Canada Only)

Most Dell devices are classified by the Industry Canada (IC) Interference-Causing Equipment Standard #3 (ICES-003) as Class B digital devices. To determine which classification (Class A or B) applies to your device, examine all registration labels located on the bottom, side, or the back panel of your device. A statement in the form of "IC Class A ICES-003" or "IC Class B ICES-003" will be located on one of these labels. Note that Industry Canada regulations provide that changes or modifications not expressly approved by Dell could void your authority to operate this equipment.

This Class B (or Class A, if so indicated on the registration label) digital apparatus meets the requirements of the Canadian Interference-Causing Equipment Regulations.

Cet appareil numérique de la Classe B (ou Classe A, si ainsi indiqué sur l'étiquette d'enregistrement) respecte toutes les exigences du Règlement sur le Matériel Brouilleur du Canada.

## CE Notice (European Union)

Marking by the symbol **CE** indicates compliance of this Dell device to the EMC Directive 89/336/CEE and the Low Voltage Directive 73/23/CEE of the European Union. Such marking is indicative that this Dell device meets the following technical standards:

- EN 55022 - "Information Technology Equipment - Radio Disturbance Characteristics - Limits and Methods of Measurement."
- EN 55024 - "Information Technology Equipment - Immunity Characteristics - Limits and Methods of Measurement."
- EN 61000-3-2 - "Electromagnetic Compatibility (EMC) - Part 3: Limits - Section 2: Limits for Harmonic Current Emissions (Equipment Input Current Up to and Including 16 A Per Phase)."
- EN 61000-3-3 - "Electromagnetic Compatibility (EMC) - Part 3: Limits - Section 3: Limitation of Voltage Fluctuations and Flicker in Low-Voltage Supply Systems for Equipment With Rated Current Up to and Including 16 A."
- EN 60950-1 - "Safety of Information Technology Equipment."

NOTE: EN 55022 emissions requirements provide for two classifications:

- Class A is for typical commercial areas.
- Class B is for typical domestic areas.

To determine which classification applies to your device, examine the FCC or ICES information on the regulatory label located on the back, side, or bottom panel of the device. If the FCC or ICES information on the label indicates a Class A rating, the following Class A warning applies to your device:

**RF INTERFERENCE WARNING:** This is a Class A product. In a domestic environment this product may cause radio frequency (RF) interference, in which case the user may be required to take adequate measures.



If the FCC or ICES information on the label indicates a Class B rating, the following Class B statement applies to your device:

This Dell device is classified for use in a typical Class B domestic environment.

A "Declaration of Conformity" in accordance with the preceding directives and standards has been made and is on file at Dell Inc. Products Europe BV, Limerick, Ireland.

---

## EN 55022 Compliance (Czech Republic Only)

This device belongs to Class B devices as described in EN 55022, unless it is specifically stated that it is a Class A device on the specification label. The following applies to devices in Class A of EN 55022 (radius of protection up to 30 meters). The user of the device is obliged to take all steps necessary to remove sources of interference to telecommunication or other devices.

Pokud není na typovém štítku počítače uvedeno, že spadá do třídy A podle EN 55022, spadá automaticky do třídy B podle EN 55022. Pro zařízení zařazená do třídy A (ochranné pásmo 30m) podle EN 55022 platí následující. Dojde-li k rušení telekomunikačních nebo jiných zařízení, je uživatel povinen provést taková opatření, aby rušení odstránil.

---

## VCCI Notice (Japan Only)

Most Dell devices are classified by the Voluntary Control Council for Interference (VCCI) as Class B information technology equipment (ITE). However, the inclusion of certain options can change the rating of some configurations to Class A. ITE, including devices, expansion cards, printers, input/output (I/O) devices, monitors, and so on, integrated into or connected to the device should match the electromagnetic environment classification (Class A or B) of the device.

To determine which classification applies to your device, examine the regulatory labels/markings located on the bottom, side, or back panel of your device. Once you have determined your device's VCCI classification, read the appropriate VCCI notice (see "VCCI Class A ITE Regulatory Mark" or "VCCI Class B ITE Regulatory Mark").

### Class A ITE

この装置は、情報処理装置等電波障害自主規制協議会 (VCCI) の基準に基づくクラス A 情報技術装置です。この装置を家庭環境で使用すると電波妨害を引き起こすことがあります。この場合には使用者が適切な対策を講ずるよう要求されることがあります。

This is a Class A product based on the standard of the Voluntary Control Council for Interference (VCCI) for information technology equipment. If this equipment is used in a domestic environment, radio disturbance may arise. When such trouble occurs, the user may be required to take corrective actions.

## VCCI Class A ITE Regulatory Mark

If the regulatory label includes the following marking, your device is a Class A product: 

## Class B ITE

この装置は、情報処理装置等電波障害自主規制協議会(VCCI)の基準に基づくクラスB情報技術装置です。この装置は家庭環境で使用することを目的としていますが、ラジオやテレビジョン受信機に近接して使用されると、受信障害を引き起こすことがあります。取扱説明書に従って正しい取り扱いをしてください。

This is a Class B product based on the standard of the Voluntary Control Council for Interference (VCCI) for information technology equipment. If this equipment is used near a radio or television receiver in a domestic environment, it may cause radio interference. Install and use the equipment according to the instruction manual.

## VCCI Class B ITE Regulatory Mark

If the regulatory label includes the following marking, your device is a Class B product:

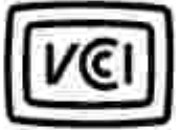

---

## MIC Notice (Republic of Korea Only)

To determine which classification (Class A or B) applies to your device, examine the Republic of Korean Ministry of Information and Communications (MIC) registration labels located on your device. The MIC label may be located separately from the other regulatory marking applied to your product. Line two of the label identifies the emissions class for the product-"(A)" for Class A products or "(B)" for Class B products.

NOTE: MIC emissions requirements provide for two classifications:

- Class A devices are for business purposes.
- Class B devices are for nonbusiness purposes.

## Class A Device

기준별	사용차안내문
A급 기기 (업무용 정보통신기기)	이 기기는 업무용으로 전자파적합등록을 한 기기이오니 판매자 또는 사용자는 이 점을 주의하시기 바라며 한약 조로 판매 또는 구매했을 때에는 기정용으로 교환하시기 바랍니다.

Please note that this device has been approved for business purposes with regard to electromagnetic

interference. If you find that this device is not suitable for your use, you may exchange it for a nonbusiness-purpose device.

## MIC Class A Regulatory Label

If the regulatory label includes the following marking, your device is a Class A product:

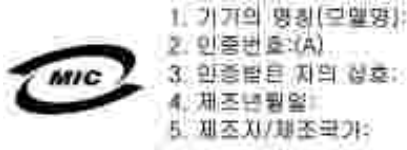

## Class B Device

기종별	사용자안내문
B급 기기 (가정용 정보통신기기)	이 기기는 가정용으로 전자파 적합등록을 한 기기로서 주거지역에서는 물론 모든 지역에서 사용할 수 있습니다.

Please note that this device has been approved for nonbusiness purposes and may be used in any environment, including residential areas.

## MIC Class B Regulatory Label

If the regulatory label includes the following marking, your device is a Class B product:



## Polish Center for Testing and Certification Notice

The equipment should draw power from a socket with an attached protection circuit (a 3-prong socket). All equipment that works together (computer, monitor, printer, and so on) should have the same power supply source.

The phasing conductor of the room's electrical installation should have a reserve short-circuit protection device in the form of a fuse with a nominal value no larger than 16 amperes (A).

To completely switch off the equipment, the power supply cable must be removed from the power supply socket, which should be located near the equipment and easily accessible.

A protection mark "B" confirms that the equipment is in compliance with the protection usage requirements of standard PN-EN 55022.

#### Wymagania Polskiego Centrum Badań i Certyfikacji

Urządzenie powinno być zasilane z gniazda z przyłączonym obwodem ochronnym (gniazdo z kolkiem).

Współpracujące ze sobą urządzenia (komputer, monitor, drukarka) powinny być zasilane z tego samego źródła.

Instalacja elektryczna pomieszczenia powinna zawierać w przewodzie fazowym rezerwową ochronę przed zwarciami, w postaci bezpiecznika o wartości znamionowej nie większej niż 16A (amperów).

W celu całkowitego wyłączenia urządzenia z sieci zasilania, należy wyjąć wtyczkę kabla zasilającego z gniazda, które powinno znajdować się w pobliżu urządzenia i być łatwo dostępne. Znak bezpieczeństwa "B" potwierdza zgodność urządzenia z wymaganiami bezpieczeństwa użytkownika zawartymi w PN-EN 60950:2000 i PN-EN 55022:2000.

Jeżeli na tabliczce znamionowej umieszczono informacje, że urządzenie jest klasy A, to oznacza, że urządzenie w środowisku mieszkalnym może powodować zakłócenia radioelektryczne. W takich przypadkach można zadać od jego użytkownika zastosowania odpowiednich środków zaradczych.

#### Pozostałe instrukcje bezpieczeństwa

- Nie należy używać wtyczek adapterowych lub używać kółka obwodu ochronnego z wtyczki. Jeżeli konieczne jest użycie przedłużacza to należy użyć przedłużacza 3-żyłowego z prawidłowo połączonym przewodem ochronnym.
- System komputerowy należy zabezpieczyć przed nagłym, chwilowym wzrostem lub spadkiem napięcia, używając eliminatora przepięć, urządzenia dopasowującego lub bezaktywnego źródła zasilania.
- Należy upewnić się, aby nie leżało na kablach systemu komputerowego, oraz aby kable nie były umieszczone w miejscu, gdzie można byłoby na nie nalepywać lub potykać się o nie.
- Nie należy rozlewać napojów ani innych płynów na system komputerowy.
- Nie należy wpychać żadnych przedmiotów do otworów systemu komputerowego, gdyż może to spowodować pożar lub porażenie prądem, poprzez zwarcie elementów wewnętrznych.
- System komputerowy powinien znajdować się z dala od grzejników i źródeł ciepła. Ponadto nie należy blokować otworów wentylacyjnych. Należy unikać kładzenia łatwych papierów pod komputer oraz umieszczania komputera w ciasnym miejscu bez możliwości cyrkulacji powietrza wokół niego.

---

## BSMI Notice (Taiwan Only)

If you find a  or  mark on the regulatory label on the bottom, side, or back panel of your device, the following section is applicable:

## BSMI 通告 (僅限於台灣)

大多數的 Dell 電腦系統經 BSMI (經濟部標準檢驗局) 劃分為乙類數位裝置。但是, 使用某些配件會使有些組態的等級變成甲類。若要確定您的電腦系統適用等級, 請檢查所有位於電腦底部或背面板、擴充卡安裝托架, 以及擴充卡上的 BSMI 註冊標籤。如果其中有一甲類標籤, 即表示您的系統為甲類數位裝置。如果只有 BSMI 的條碼或碼標籤, 則表示您的系統為乙類數位裝置。

一旦確定了系統的 BSMI 等級, 請閱讀相關的 BSMI 通告。請注意, BSMI 通告規定凡是未經 Dell Inc. 明確批准的擅自變更或修改, 將導致您失去此設備的使用權。

此裝置符合 BSMI (經濟部標準檢驗局) 的規定, 使用時須符合以下兩項條件:

- 此裝置不會產生有害干擾。
- 此裝置必須能接受所接收到的干擾, 包括可能導致無法正常作業的干擾。

## 甲類

此設備經測試證明符合 BSMI (經濟部標準檢驗局) 之甲類數位裝置的限制規定。這些限制的目的是為了在商業環境中使用此設備時, 能提供合理的保護以防止有害的干擾。此設備會產生、使用並散發射頻能量; 如果未遵照製造廠商的指導手冊來安裝和使用, 可能會干擾無線電通訊。請勿在住宅區使用此設備。

**警告使用者:**  
這是甲類的資訊產品, 在居住的環境中使用時, 可能會造成射頻干擾。  
在這種情況下, 使用者會被要求採取某些適當的對策。

## 乙類

此設備經測試證明符合 BSMI (經濟部標準檢驗局) 之乙類數位裝置的限制規定。這些限制的目的是為了在住宅區安裝時, 能防止有害的干擾, 提供合理的保護。此設備會產生、使用並散發射頻能量; 如果未遵照製造廠商的指導手冊來安裝和使用, 可能會干擾無線電通訊。但是, 這並不保證在個別的安装中不會產生干擾。您可以透過隔開和調整此設備來判斷它是否會對廣播和電視接收造成干擾; 如果確實如此, 我們建議您嘗試以下列一種或多種方法來排除干擾:

- 重新調整天線的接收方向或重新設置接收天線。
- 增加設備與接收器的距離。
- 將設備連接到不同的插座, 使設備與接收器連接到不同的電路上。
- 請向經銷商或有經驗的無線電 / 電視技術人員查詢, 以獲得幫助。

---

## NOM Information (Mexico Only)

The following information is provided on the device(s) described in this document in compliance with the requirements of the official Mexican standards (NOM):

Exporter:	Dell Inc. One Dell Way Round Rock, TX 78682
Importer:	Dell Computer de México, S.A. de C.V. Paseo de la Reforma 2620 - 11° Piso Col. Lomas Altas 11950 México, D.F.
Ship to:	Dell Computer de México, S.A. de C.V. al Cuidado de Kuehne & Nagel de México S. de R.L. Avenida Soles No. 55 Col. Peñon de los Baños 15520 México, D.F.
Model number:	924
Supply voltage:	100/240 VAC
Frequency:	50/60 Hz
Current consumption:	1.0 A
Output voltage:	30 VDC
Output current:	0.83 A

## ENERGY STAR® Compliance

Any Dell product bearing the ENERGY STAR® emblem on the product or on a start-up screen is certified to comply with Environmental Protection Agency (EPA) ENERGY STAR® requirements as configured when shipped by Dell. You can also help reduce electricity usage and its side effects by turning off your product when it is not in use for extended periods of time, particularly at night and on weekends.

ENERGY STAR® Emblem



# Appendix

- [Dell Technical Support Policy](#)
  - [Contacting Dell](#)
  - [Warranty and Return Policy](#)
- 

## Dell Technical Support Policy

Technician-assisted technical support requires the cooperation and participation of the customer in the troubleshooting process and provides for restoration of the Operating System, application software and hardware drivers to the original default configuration as shipped from Dell, as well as the verification of appropriate functionality of the printer and all Dell-installed hardware. In addition to this technician assisted technical support, online technical support is available at Dell Support. Additional technical support options may be available for purchase.

Dell provides limited technical support for the printer and any Dell-installed software and peripherals. Support for third-party software and peripherals is provided by the original manufacturer, including those purchased and/or installed through Software & Peripherals (DellWare), ReadyWare, and Custom Factory Integration (CFI/DellPlus).

---

## Contacting Dell

You can access Dell Support at [support.dell.com](http://support.dell.com). Select your region on the WELCOME TO DELL SUPPORT page, and fill in the requested details to access help tools and information.

You can contact Dell electronically using the following addresses:

- World Wide Web  
[www.dell.com/](http://www.dell.com/)  
[www.dell.com/ap/](http://www.dell.com/ap/) (for Asian/Pacific countries only)  
[www.euro.dell.com](http://www.euro.dell.com/) (for Europe only)  
[www.dell.com/la/](http://www.dell.com/la/) (for Latin American countries)  
[www.dell.com/jp/](http://www.dell.com/jp/) (for Japan only)
- Anonymous file transfer protocol (FTP)  
[ftp.dell.com/](ftp://ftp.dell.com/)  
Log in as user: anonymous, and use your email address as your password.
- Electronic Support Service  
[mobile\\_support@us.dell.com](mailto:mobile_support@us.dell.com)  
[support@us.dell.com](mailto:support@us.dell.com)  
[apsupport@dell.com](mailto:apsupport@dell.com) (for Asian/Pacific countries only)  
[support.euro.dell.com](mailto:support.euro.dell.com) (for Europe only)
- Electronic Quote Service  
[sales@dell.com](mailto:sales@dell.com)



apmarketing@dell.com (for Asian/Pacific countries only)

- Electronic Information Service  
info@dell.com
- 

## Warranty and Return Policy

Dell Inc. ("Dell") manufactures its hardware products from parts and components that are new or equivalent to new in accordance with industry-standard practices. For information about the Dell warranty for your printer, refer to the *Owner's Manual*.



# Licensing Notice

The printer resident software contains:

- Software developed and copyrighted by Dell and/or third parties
- Dell modified software licensed under the provisions of the GNU General Public License version 2 and the GNU Lesser General Public License version 2.1
- Software licensed under the BSD license and warranty statements

Click the title of the document you want to review:

- [BSD License and Warranty Statements](#)
- [GNU License](#)

The Dell modified GNU licensed software is free software; you can redistribute it and/or modify it under the terms of the licenses referenced above. These licenses do not provide you any rights to the Dell- or third-party-copyrighted software in this printer.

Since the GNU licensed software that the Dell modifications are based upon is supplied explicitly without warranty, use of the Dell modified version is similarly provided without warranty. See the warranty disclaimers in the referenced licenses for additional details.

To obtain source code files for the Dell modified GNU licensed software, launch the *Drivers and Utilities CD* that shipped with your printer and click Contact Dell, or refer to the "Contacting Dell" section of your *Owner's Manual*.